

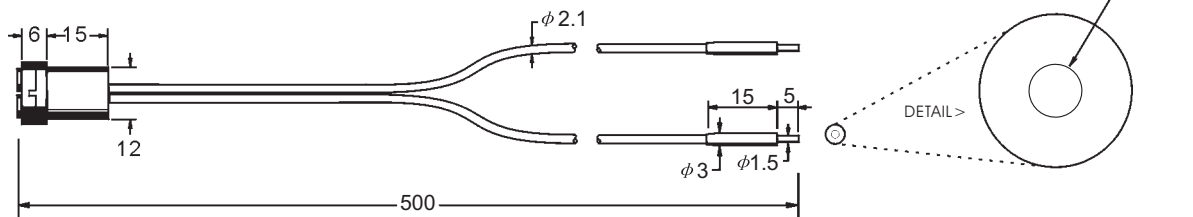

Dimensions (mm)	Model number	Length	Bundle	Sheath	Range (mm)
-----------------	--------------	--------	--------	--------	------------

MBN.8P

MBN.8P	500	ϕ 0.8	PVC
--------	-----	------------	-----



Dimensions (mm)	Model number	Length	Bundle	Sheath	Range (mm)
-----------------	--------------	--------	--------	--------	------------

MBN1.1P

MBN1.1P	500	ϕ 1.1	PVC
---------	-----	------------	-----

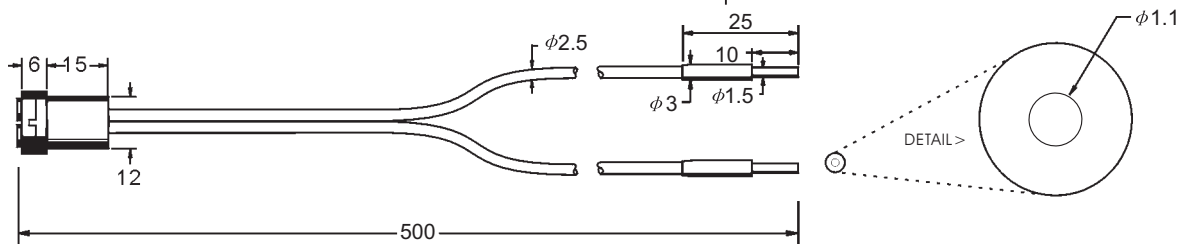

Dimensions (mm)	Model number	Length	Bundle	Sheath	Range (mm)
-----------------	--------------	--------	--------	--------	------------

MBN1.1P-1

MBN1.1P-1	500	ϕ 1.1	PVC
-----------	-----	------------	-----

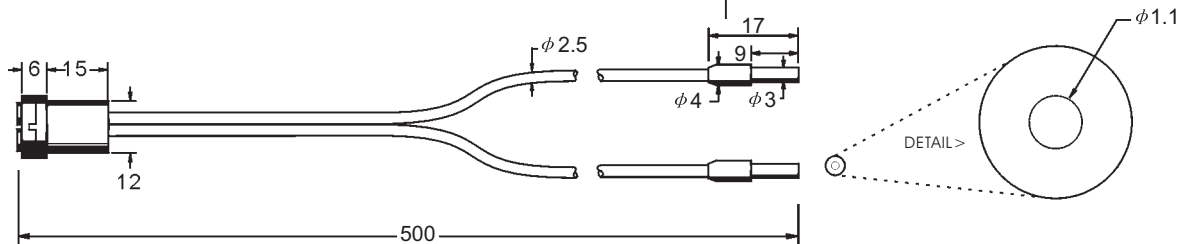

Dimensions (mm)	Model number	Length	Bundle	Sheath	Range (mm)
-----------------	--------------	--------	--------	--------	------------

MBN1.6R

MBN1.6R	500	ϕ 1.6	PUR
---------	-----	------------	-----

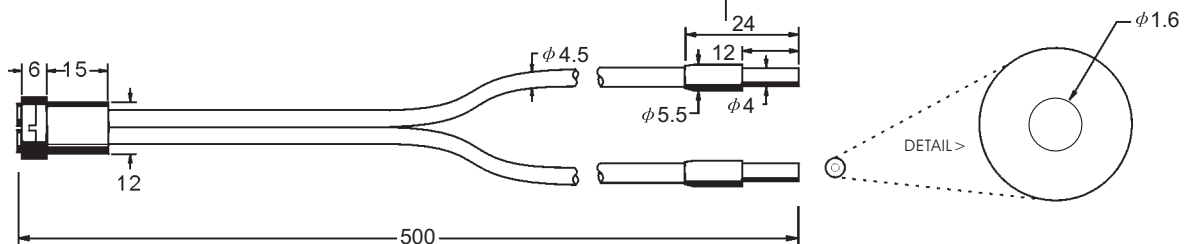

Individual Cables

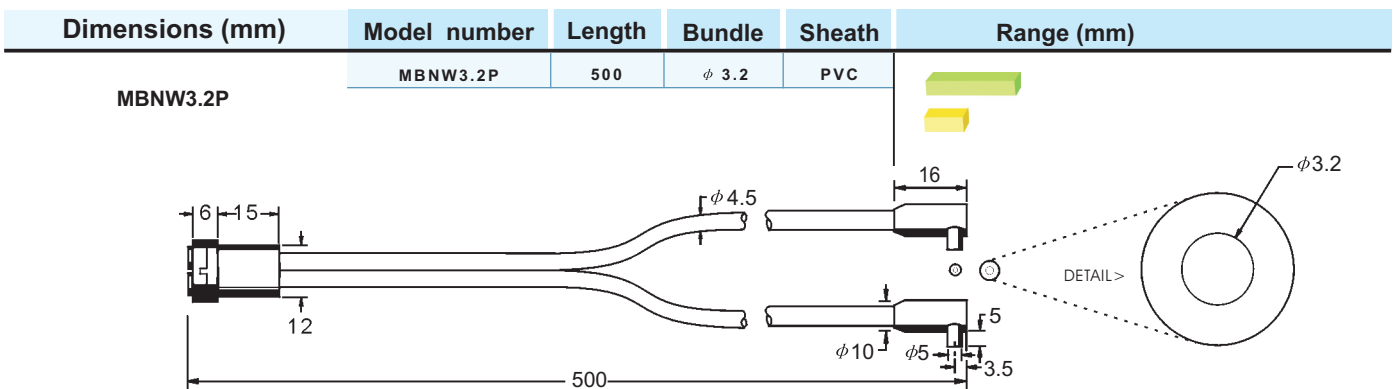
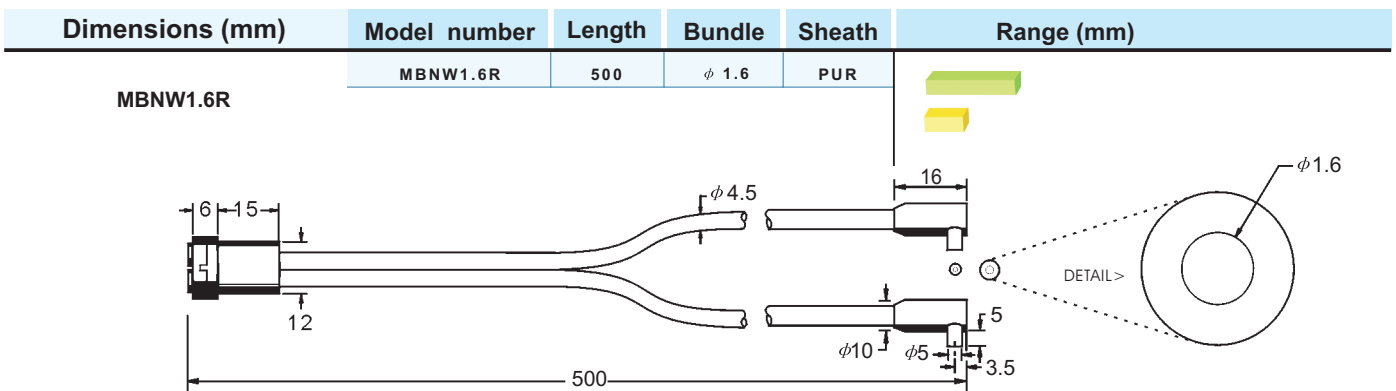
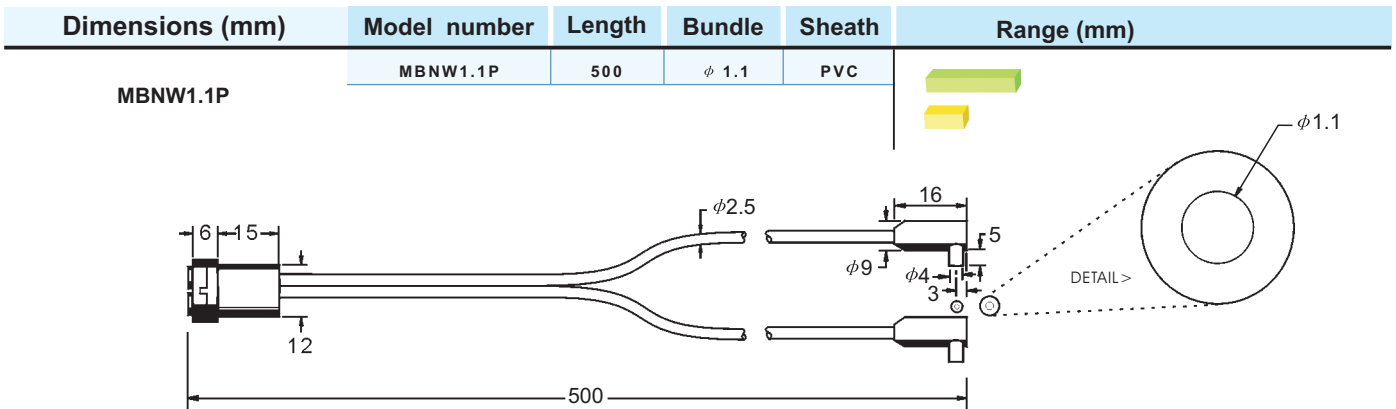
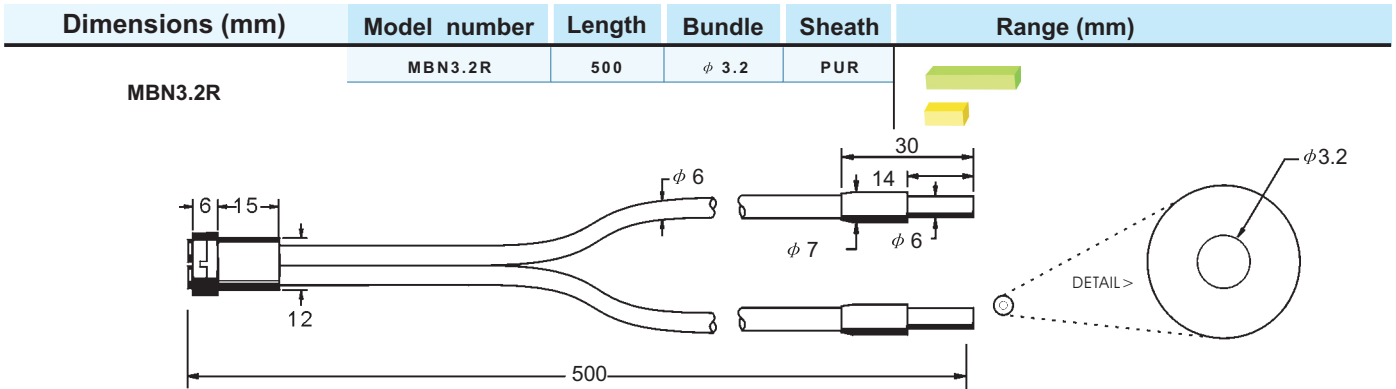



Dimensions (mm)	Model number	Length	Bundle	Sheath	Range (mm)
-----------------	--------------	--------	--------	--------	------------

MBC1.1P

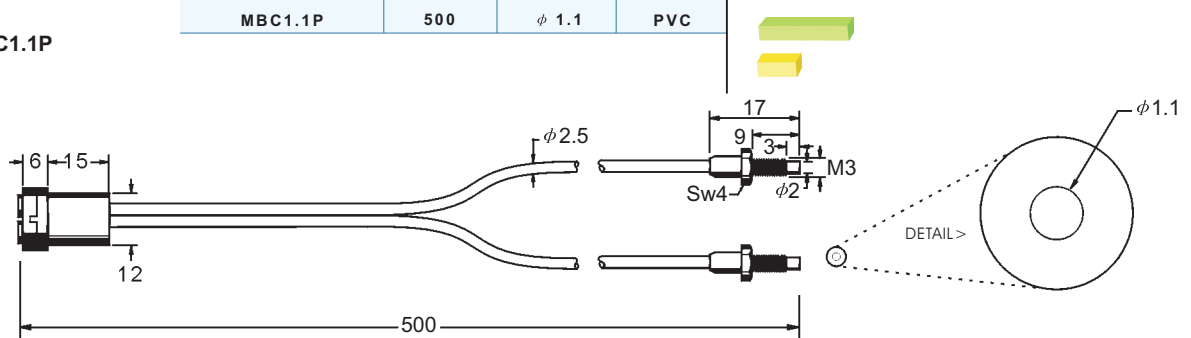

Dimensions (mm)	Model number	Length	Bundle	Sheath	Range (mm)
-----------------	--------------	--------	--------	--------	------------

MBC1.6R

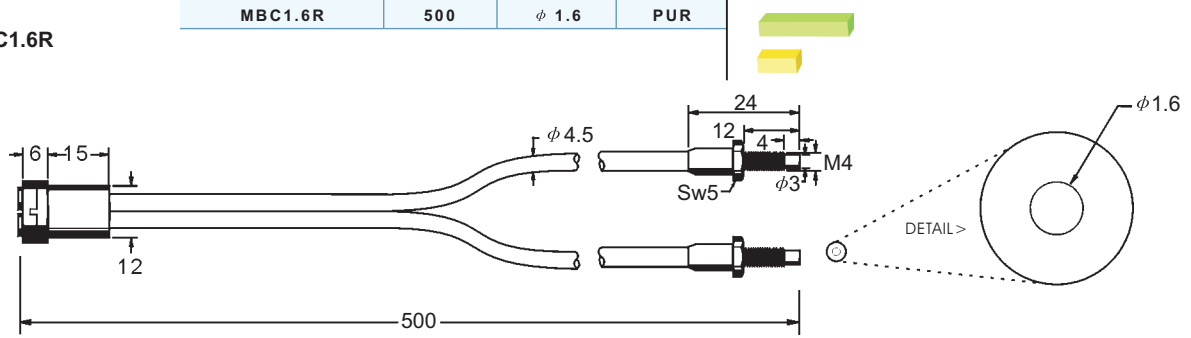

Dimensions (mm)	Model number	Length	Bundle	Sheath	Range (mm)
-----------------	--------------	--------	--------	--------	------------

MBC3.2P

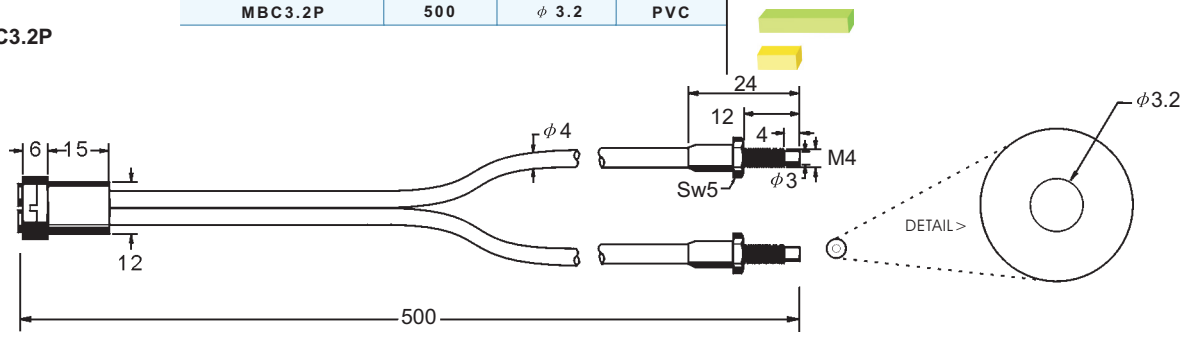

Dimensions (mm)	Model number	Length	Bundle	Sheath	Range (mm)
-----------------	--------------	--------	--------	--------	------------

MBNW2.3W-3

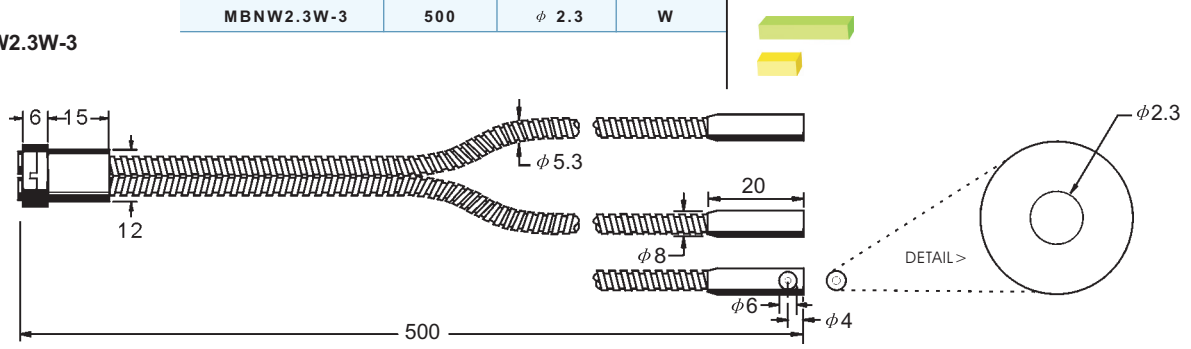



Dimensions (mm)	Model number	Length	Bundle	Sheath	Range (mm)
-----------------	--------------	--------	--------	--------	------------

MBN3.2M

MBN3.2M	500	ϕ 3.2	M	
---------	-----	------------	---	--

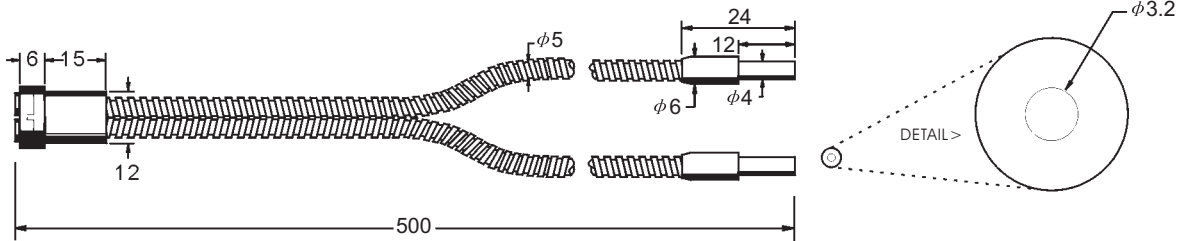

Dimensions (mm)	Model number	Length	Bundle	Sheath	Range (mm)
-----------------	--------------	--------	--------	--------	------------

MBB1.1N

MBB1.1N	500	ϕ 1.1	N	
---------	-----	------------	---	--

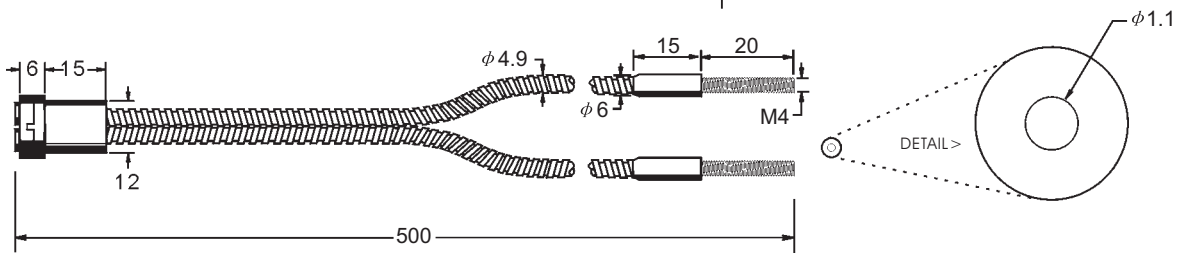

Dimensions (mm)	Model number	Length	Bundle	Sheath	Range (mm)
-----------------	--------------	--------	--------	--------	------------

MBB1.6N

MBB1.6N	500	ϕ 1.6	N	
---------	-----	------------	---	--

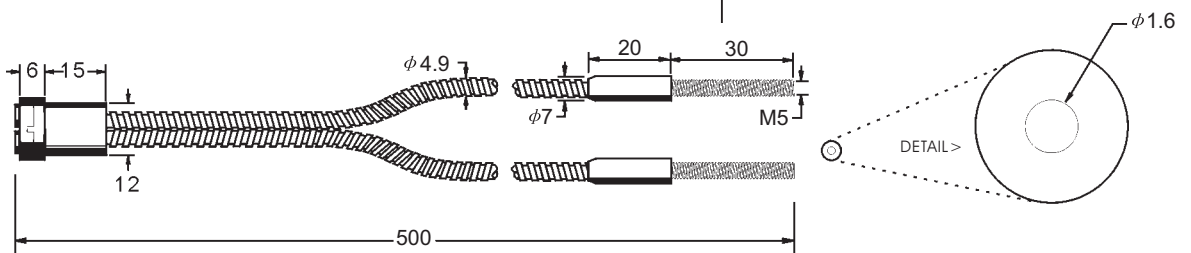

Dimensions (mm)	Model number	Length	Bundle	Sheath	Range (mm)
-----------------	--------------	--------	--------	--------	------------

MBF1.6M

MBF1.6M	500	ϕ 1.6	M	
---------	-----	------------	---	--

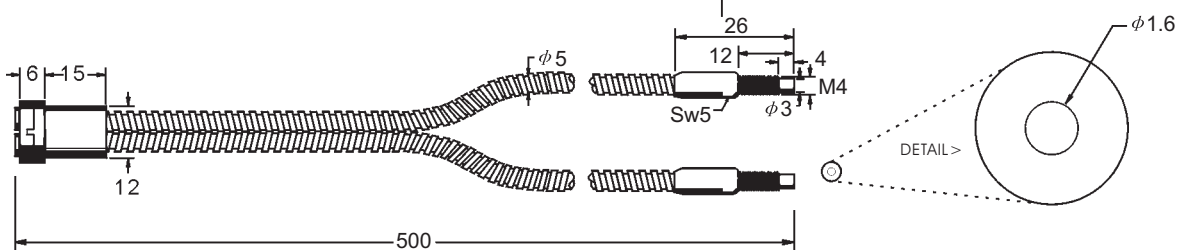

Individual Cables



Dimensions (mm)	Model number	Length	Bundle	Sheath	Range (mm)
-----------------	--------------	--------	--------	--------	------------

MBF3.2M

MBF3.2M	500	ϕ 3.2	M	
---------	-----	------------	---	--

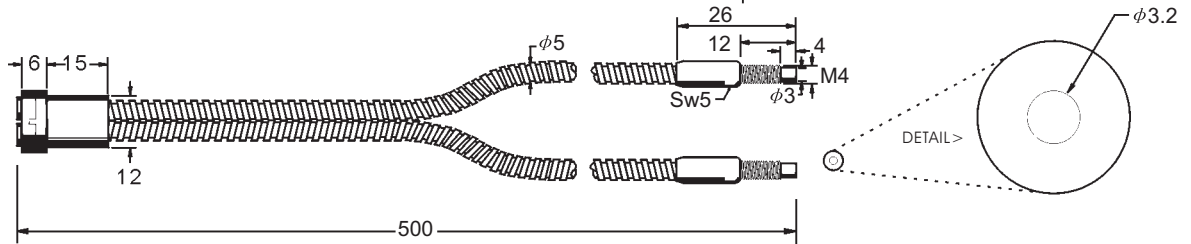

Dimensions (mm)	Model number	Length	Bundle	Sheath	Range (mm)
-----------------	--------------	--------	--------	--------	------------

MBC1.1M

MBC1.1M	500	ϕ 1.1	M	
---------	-----	------------	---	--

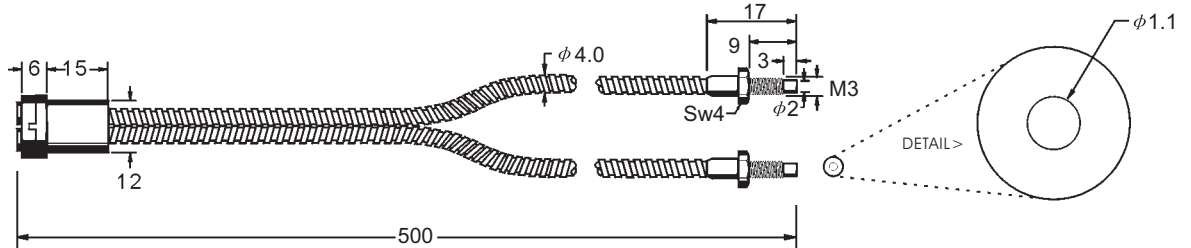

Dimensions (mm)	Model number	Length	Bundle	Sheath	Range (mm)
-----------------	--------------	--------	--------	--------	------------

MBNW1.6M

MBNW1.6M	500	ϕ 1.6	M	
----------	-----	------------	---	--

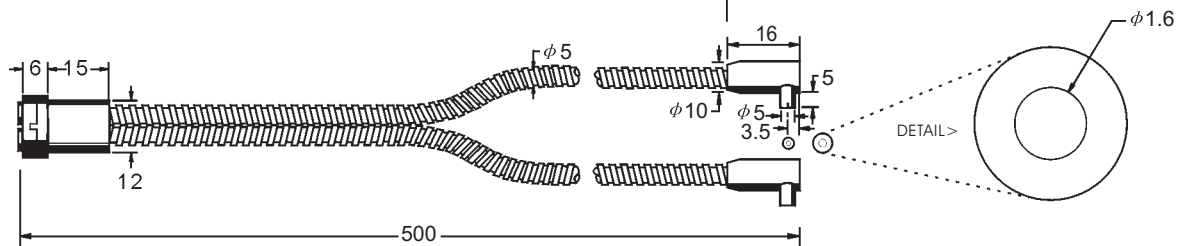

Dimensions (mm)	Model number	Length	Bundle	Sheath	Range (mm)
-----------------	--------------	--------	--------	--------	------------

MBNW3.2M

MBNW3.2M	500	ϕ 3.2	M	
----------	-----	------------	---	--

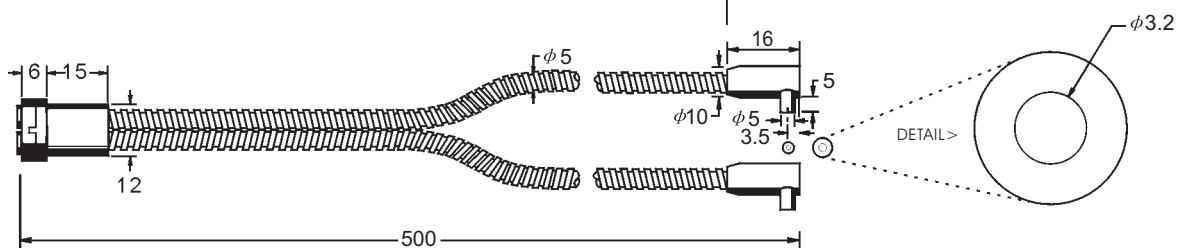



Dimensions (mm)	Model number	Length	Bundle	Sheath	Range (mm)
-----------------	--------------	--------	--------	--------	------------

MBNW2.3W

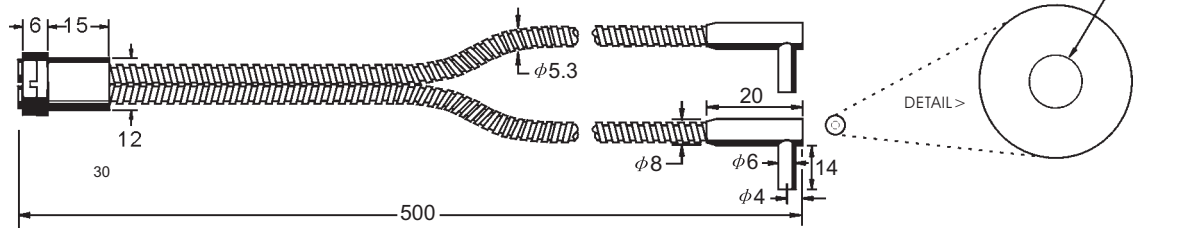

Dimensions (mm)	Model number	Length	Bundle	Sheath	Range (mm)
-----------------	--------------	--------	--------	--------	------------

MBNW2.3W-1

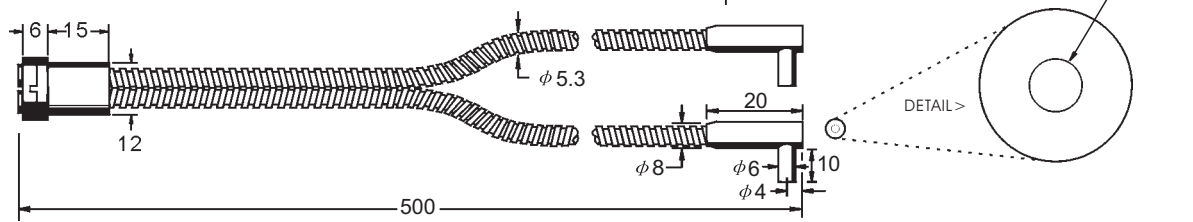

Dimensions (mm)	Model number	Length	Bundle	Sheath	Range (mm)
-----------------	--------------	--------	--------	--------	------------

MBNW2.3W-2

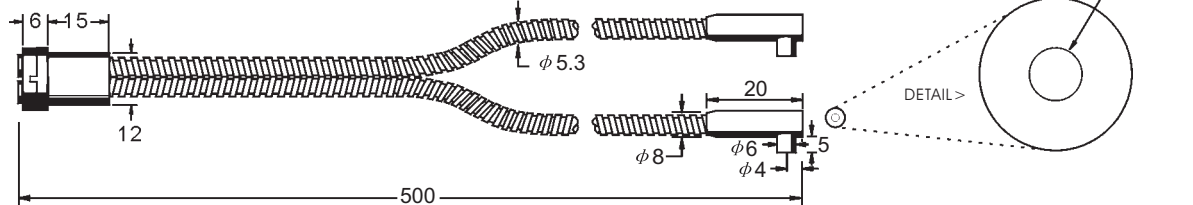

Dimensions (mm)	Model number	Length	Bundle	Sheath	Range (mm)
-----------------	--------------	--------	--------	--------	------------

MBNW1.6N

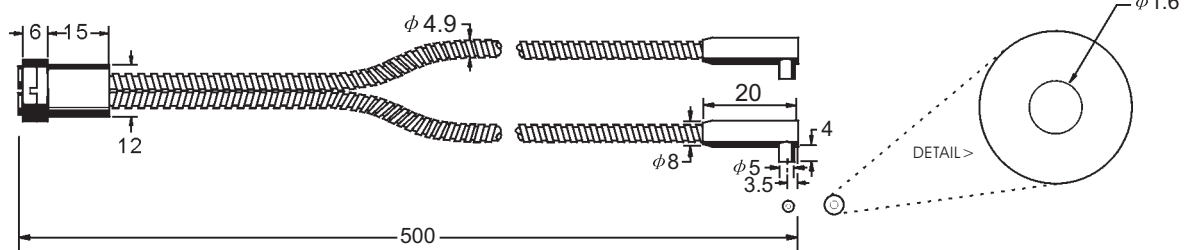

Individual Cables



Dimensions (mm)	Model number	Length	Bundle	Sheath	Range (mm)
-----------------	--------------	--------	--------	--------	------------

MBNW1.1M

MBNW1.1M	500	ϕ 1.1	M	
----------	-----	------------	---	--

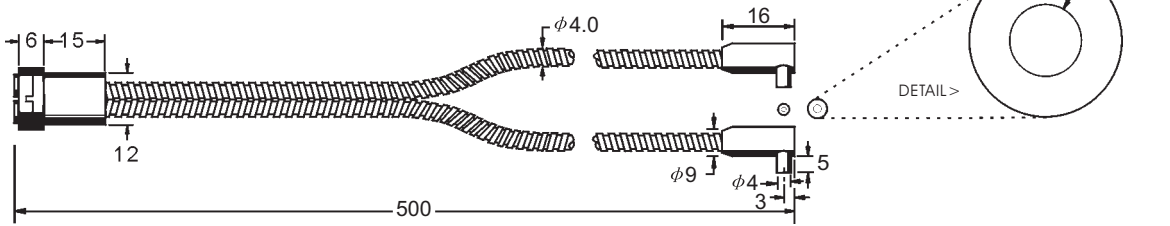

Dimensions (mm)	Model number	Length	Bundle	Sheath	Range (mm)
-----------------	--------------	--------	--------	--------	------------

--	--	--	--	--



Dimensions (mm)	Model number	Length	Bundle	Sheath	Range (mm)
-----------------	--------------	--------	--------	--------	------------

--	--	--	--	--



Dimensions (mm)	Model number	Length	Bundle	Sheath	Range (mm)
-----------------	--------------	--------	--------	--------	------------

--	--	--	--	--





Dimensions (mm)	Model number	Length	Bundle	Sheath	Range (mm)
-----------------	--------------	--------	--------	--------	------------

EBNW0.8P

EBNW0.8C	500	ϕ 0.8	PVC	
----------	-----	------------	-----	--

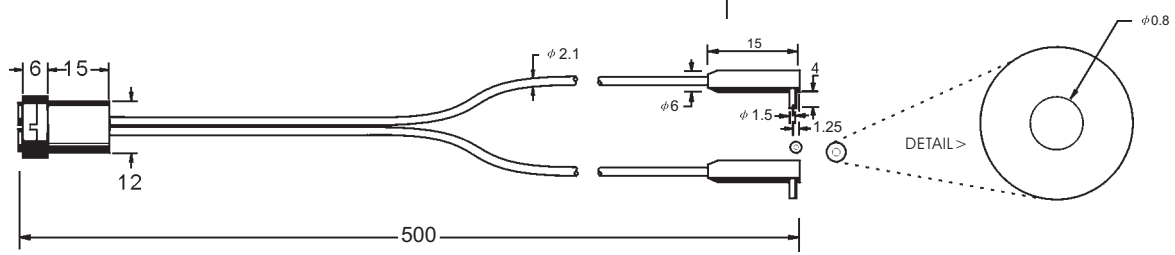
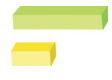

Dimensions (mm)	Model number	Length	Bundle	Sheath	Range (mm)
-----------------	--------------	--------	--------	--------	------------

--	--	--	--	--



Dimensions (mm)	Model number	Length	Bundle	Sheath	Range (mm)
-----------------	--------------	--------	--------	--------	------------

--	--	--	--	--



Dimensions (mm)	Model number	Length	Bundle	Sheath	Range (mm)
-----------------	--------------	--------	--------	--------	------------

--	--	--	--	--

