

Dimensions (Unit: mm)

T: MP SERIES

Standard Type Sensor

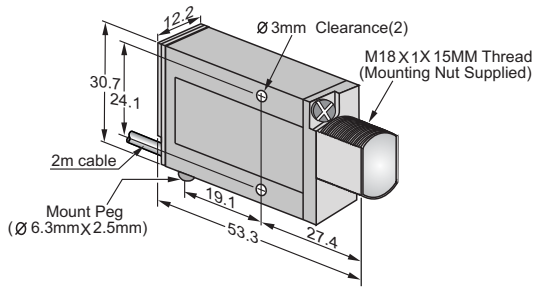

DC Type Sensor

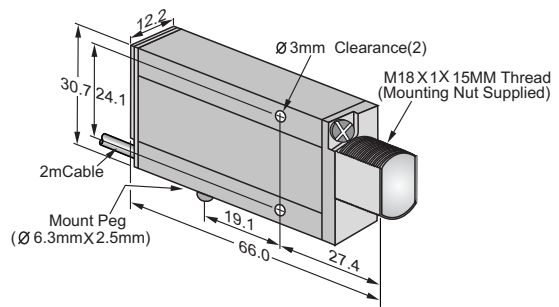

AC & AC/DC Type Sensor

Diffuse Mode Sensor (Sn=130mm, Sn=300mm)

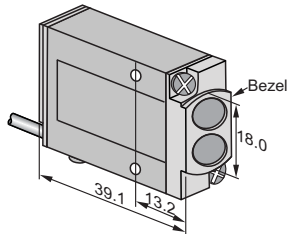

DC Type Sensor

Glass Fiber Optic Mode Sensor

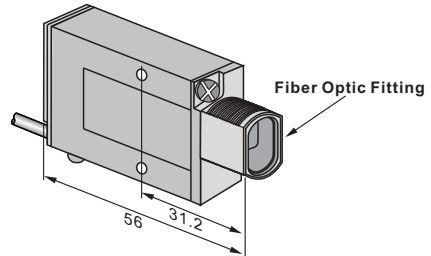

DC Type Sensor

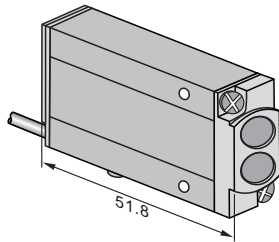

AC & AC/DC Type Sensor

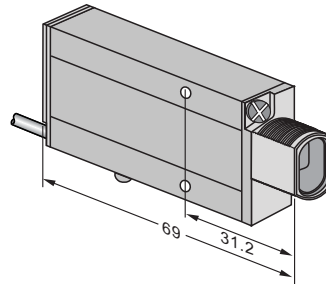

AC & AC/DC Type Sensor

Plastic Fiber Optic Mode Sensor

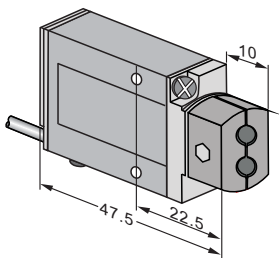

DC Type Sensor

Pigtail* Type

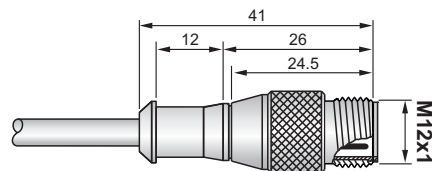
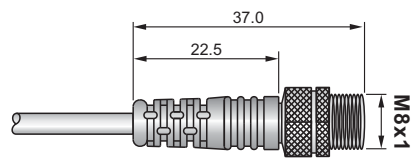

*: Please see **Pigtail Series** or our **Cables & Connectors** catalogue for more information.

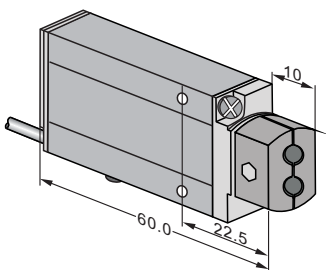

AC & AC/DC Type Sensor